

# Video Intercom Doorbell for Villas

## Instructions for Installation and Operation

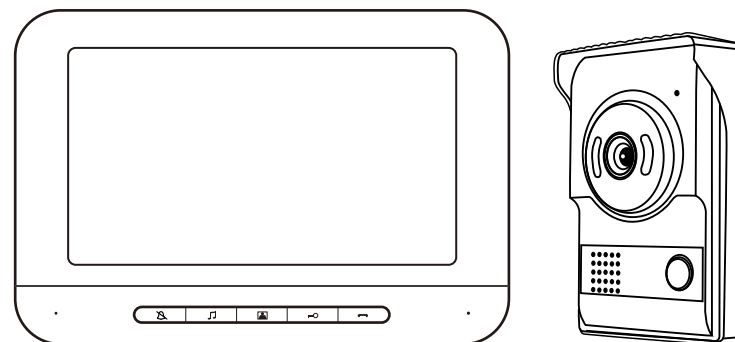

Please read the instructions carefully before using to guarantee correct and proper operation

# I. Product Description

## 1.Product introduction

The product is a wired color video intercom doorbell system. The system is composed of two parts, outdoor unit and indoor unit. The two units are connected with four-core cables. 15V DC is used for the indoor unit to realize the functions such as doorbell calling, monitor, intercommunication, and remote unlocking.

Imported TFT-LCD is used for the display screen to provide clear images, bright and distortionless colors. A high-definition CMOS camera is used to provide good night vision effects.

The intercom and doorbell are loud and clear. According to the manual, the effective transmission distance is as long as 100m (Page 9 of the manual – Wiring Requirements); if it is used with a multi-door controller, at most four outdoor unit extensions can be extended to realize the access control for various entrances.

It is applicable to places such as households, villas, apartments, offices, and hospitals.

# II. Indoor Unit

## 1.Product introduction (Please refer to corresponding figure)

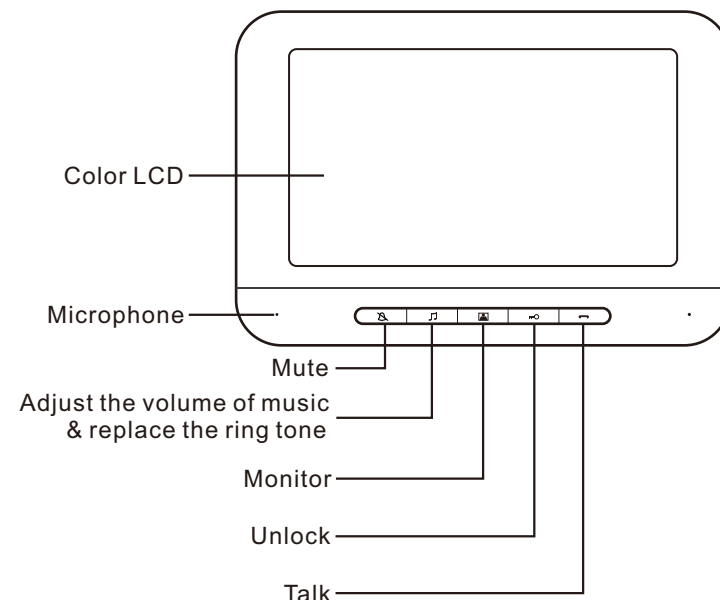

Figure 1

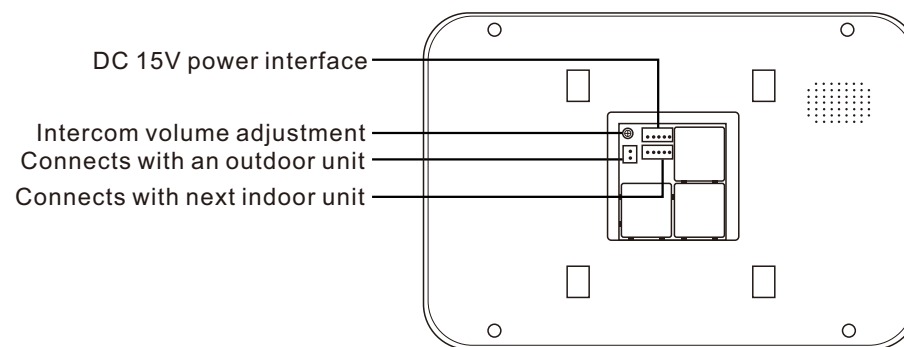





Figure 2

## 2.Functions of indoor unit



### A.Indoor unit ringtone setting

#### 1.Mute setting



In the standby mode of the indoor unit, press the button “” first to turn on the screen, and then press the button “” to turn off the bell and intercom, making no effects on image display. If it is required to turn on the bell and intercom, press the button “” again in the monitor “” mode.

- **Disturbance-free mode will be activated after the mute function is enabled**

#### 2.Change ringtone

In the standby mode of the indoor unit, press the button “” first to turn on the screen, and then press the button “” to activate the ringtone and enter “change ringtone” settings. The system is equipped with 25 ringtones of various lengths. The button “” is pressed once to change one ringtone. After a suitable ringtone is selected, stop pressing the button. The last ringtone will be the ringtone when the system is called by anyone.

#### 3.Ringtone volume adjustment

In the standby mode of the indoor unit, press the button “” first to turn on the screen, and then press the button “” to activate the ringtone and enter “ringtone volume” settings. It has three levels, large, medium and small. Press the button “” for two seconds each time to increase or decrease the volume progressively.

- **After power-off, all ringtone settings will be restored to factory settings**

### B. Instructions for doorbell operation



1. When any visitor presses the call button on the outdoor unit, the indoor unit screen will display the outdoor image in real time and the bell will ring.



2.The indoor user may press the button “” to talk with the visitor.

Note: Talking will be enabled by pressing the button “” for the first time, and it will be disabled if the button is pressed again. The screen will be off automatically in 30 seconds if the calling is not answered.

3. In the intercom mode, the indoor user may press the button “” to open the door.

4. In the intercom mode, the indoor user may press the button “” to finish talking or talking will finish automatically in 90 seconds.

5.If it is required to resume talking after hang-up, press the button “” first and then the button “” to talk with the visitor.

6.In the standby mode of the indoor unit, press the button “” first and then the button “” to unlock the door; the screen will be off automatically in 90 seconds or it can be powered off by pressing the button “” once.

## 3.Instructions for indoor unit installation

### A. Installation & location of indoor unit

At first, determine the location and height for installing the indoor unit; the reference height is 150-165cm from the display screen center to ground.

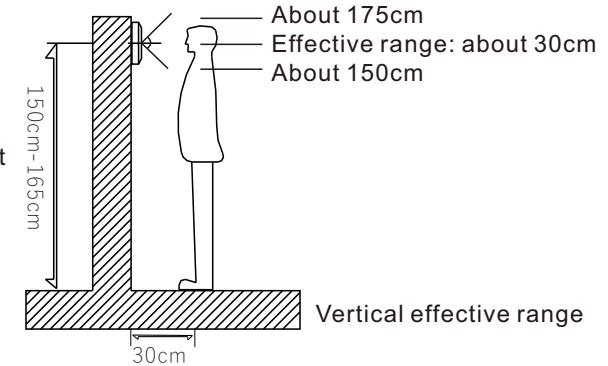

Figure 3

Vertical effective range

### B. Make a mark and drill a hole on the wall

Make a mark and drill a hole after finishing location on the wall

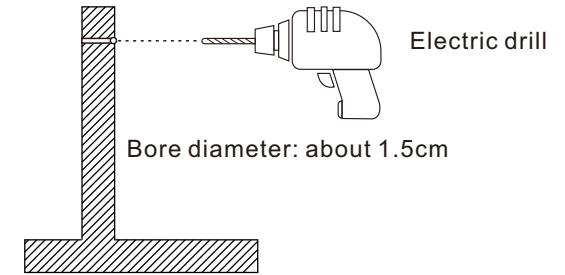

Figure 4

### C. Fix the indoor unit hanging board

As shown in the figure: Take out the hanging board; open the package of screws to take out the rubber plug and screws

1. Drill a hole, bore diameter: about 6mm;
2. Fix the rubber plug at the above hole;
3. Fix the hanging board with screws.

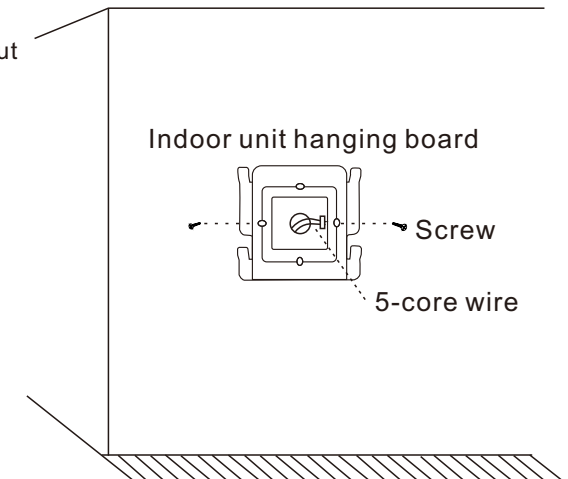

Figure 5

## D. Fix the indoor unit

1. Take out the indoor unit and power supply;
2. Insert the power plug and 4-core connector;
3. Horizontally hang the indoor unit on the fixed hanging board.

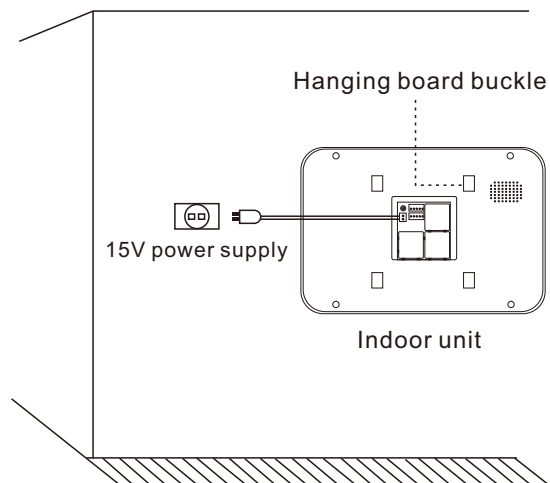

Figure 6

## 4. Parameters of indoor unit

Screen	Color HD TFT LCD
Resolution	800*480
Power supply	Input: AC100-240 Output: DC15V 1200mA
Power	Standby: $\leq 1W$ Operating: $\leq 10W$
Wiring terminal	4PX2.54/5PX2.54
Operating temperature	-20°C-60°C
Monitoring time	90 seconds
Talking time	90 seconds
Number of calling ringtones	25

## III. Outdoor unit

### 1. Product introduction

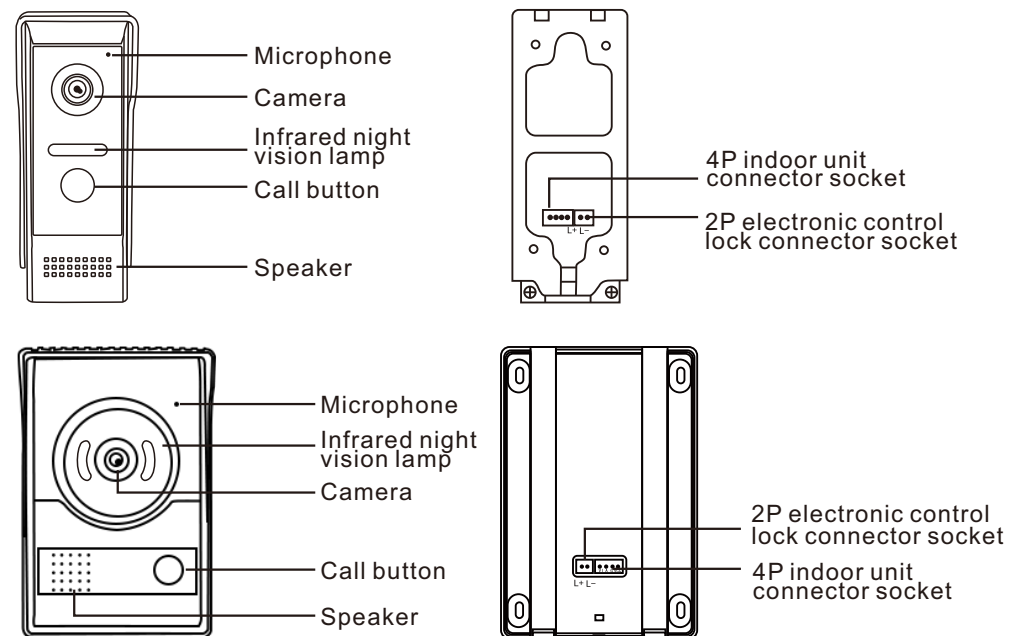

Figure 7

### 2. Functions of outdoor unit

#### A. Calling & intercom

A visitor presses the call button on the outdoor unit to call the indoor by pressing one key; intercom talking can be made after the indoor unit is answered;

#### B. Night vision

An infrared or white light night vision lamp is used to clearly see any visitor one meter away at night;

#### C. Rain-proof

Equipped with a rain cover, Ingress protection – level 4, for outdoor uses;

#### D. Outdoor unit unlocking

With 12V unlocking voltage signals, it can be directly connected with a 12V electronic control lock. If any other type of electronic control locks is used, access control power supply with (control +, control-) 12V terminal control shall be available.

### 3. Installation of outdoor unit

#### A. Installation and location of outdoor unit

At first, determine the location and height for installing the outdoor unit; the reference height is 150-165cm from the outdoor unit center to ground.

It's required to avoid installing the outdoor unit at any place with strong direct sunlight.

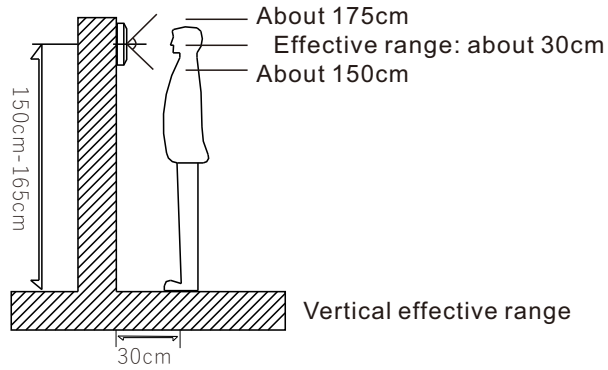

Figure 8

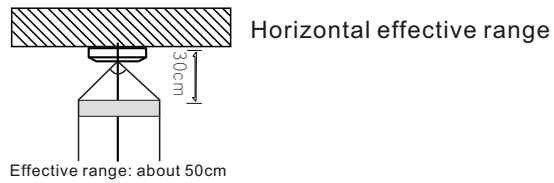

Figure 9

#### B. Make a mark and drill a hole on the wall

Make a mark and drill a hole after finishing location on the wall.

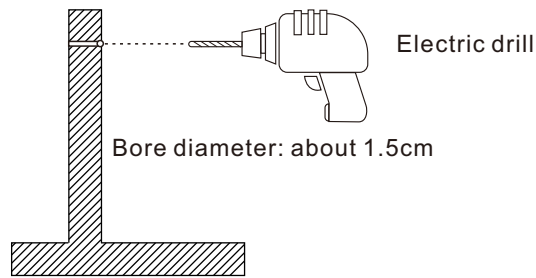

Figure 10

#### C. Fix the outdoor unit rain cover

As shown in the figure: Take out the rain cover; open the package of screws to take out the rubber plug and screws

1. Drill a hole, bore diameter: about 6mm;
2. Fix the rubber plug at the above hole;
3. Fix the hanging board with screws.

● For outdoor installation, waterproofing treatment shall be made for the wall.

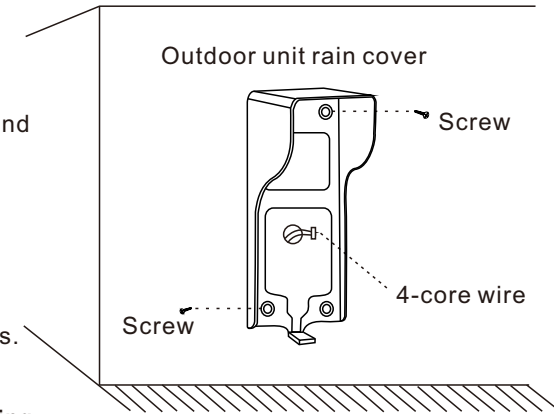

Figure 11

#### D. Fix the outdoor unit

1. Take out the outdoor unit;
2. Connect the 4-core connector and 2-core connecting connector;
3. Put the outdoor unit body behind the rain cover and fix the bottom with a hexagonal screw.

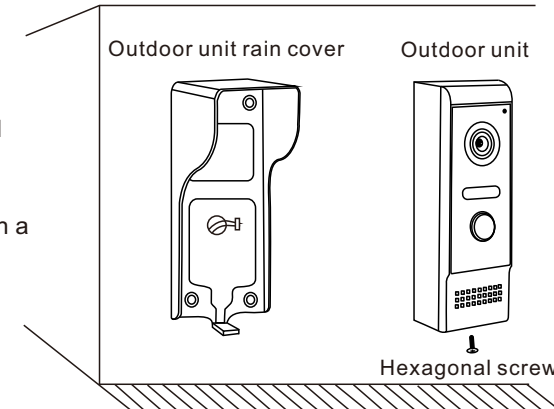

Figure 12

#### E. Completion of installation

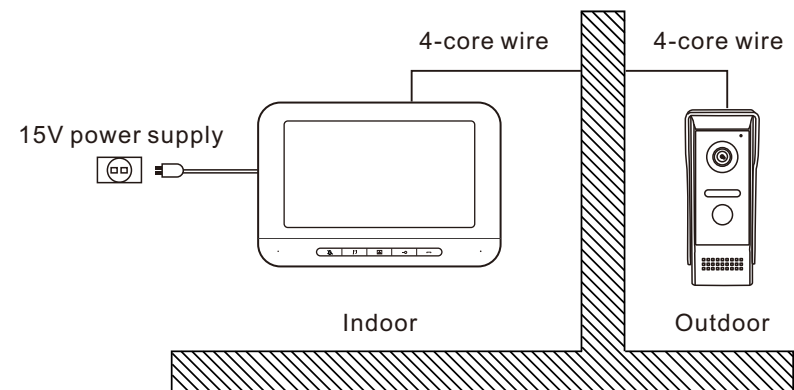

Figure 13

## 4.Parameters of outdoor unit

Camera	HD CMOS camera
Rain cover	With a rain cover
Power supply	Indoor unit power supply
Power	Standby: ≤1W Operating: ≤2W
Wiring terminal	4PX2.54
Unlocking terminal	2PX2.54
Operating temperature	-20°C-60°C
Night vision	Infrared or white light night vision lamp
Unlocking voltage	DC12V

## IV. Wiring

### 1. Wiring requirements

#### A. Intercom wiring requirements

Based on various distances, the wiring and wire diameter requirements are different. The table below lists the wire requirements for different distances:

1-30m	RVV4*0.30
31-50m	RVV4*0.50
51-100m	RVV4*1.0

Colors and functions of wiring terminals:  
 Yellow --- Video Blue --- Audio  
 Black --- Ground wire Red --- VCC

#### B. Power supply wiring requirements

1. It's not allowed to arrange power supply wiring and AC or other high frequency wire in the same conduit, and the spacing distance shall be larger than 60cm.
2. The power supply wire for the indoor unit may be laid with intercom wiring in the same conduit.

#### C. Effective distance

Distance from outdoor unit to indoor unit < 100M (Refer to Figure 14)

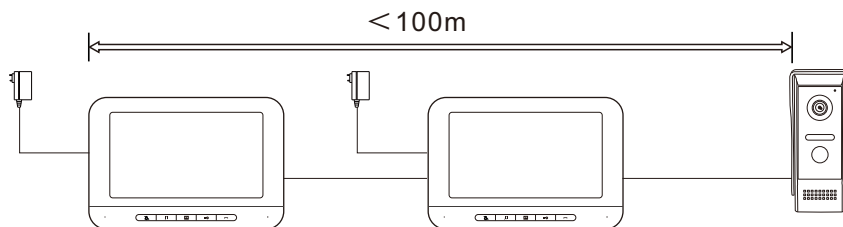

Figure 14

## 2.Wiring diagram

### A.One outdoor unit connects with one or more indoor units

When it connects with 1-4 indoor units,series connection is made to connect these screens.

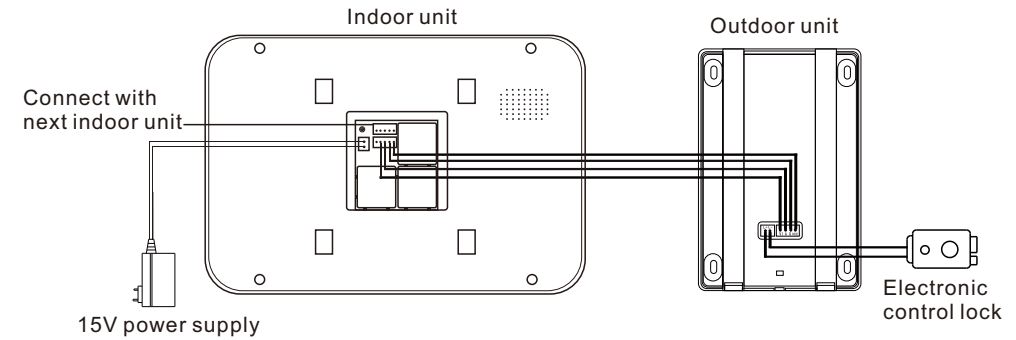
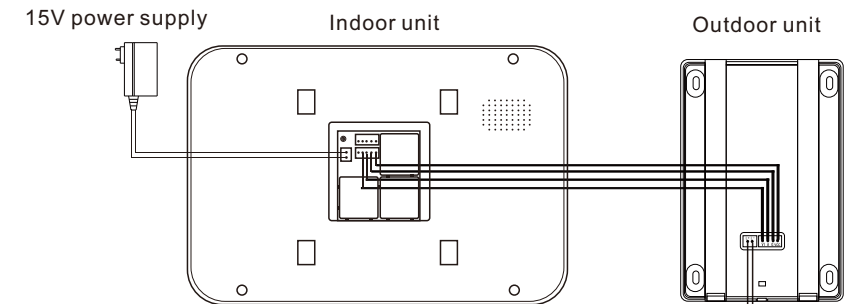

Figure 15

VIDEO—Yellow AUDIO—Blue GND---Black VCC—Red CALL—Green  
 +15V---Red L- ---Black L+---Red

### B.In combination with access control power supply wiring



Note: For the operation of access control power supply, please refer to the operation manual for the access control power supply purchased by yourself.

Figure 16

# V. Troubleshooting

Failure Type	Failure Description	Failure Elimination
Sound	No intercom sound	Inspect whether the connection wires of various colors are properly connected and whether the indoor unit can hear the sounds from the outdoor unit.
	Anyone at the indoor unit cannot hear what one says in front of the outdoor unit	<ol style="list-style-type: none"> <li>Whether there is ringtone during calling? The mainboard or microphone of the outdoor unit needs to be repaired or replaced if no ringtone or intercom sound can be heard.</li> <li>The indoor unit mainboard needs to be repaired or replaced if no ringtone or intercom sound can be heard during calling.</li> </ol>
	Anyone at the outdoor unit cannot hear what one says in front of the indoor unit	<ol style="list-style-type: none"> <li>Inspect whether a ringback can be heard on the outdoor unit when calling the indoor unit, the ringback means that the outdoor unit works normally.</li> <li>If any talk cannot be heard if a ringback can be heard on the outdoor unit, it means that the indoor unit mainboard or microphone has a failure.</li> <li>If no ringback is heard, it means that the speaker or mainboard of the outdoor unit has a failure.</li> </ol>
	The intercom sound is low	<ol style="list-style-type: none"> <li>First of all, determine the distance from the speaker's mouth to the microphone.</li> <li>Inspect whether the turbine is rotated to the maximum level.</li> <li>Inspect whether the wire diameter exceeds the specified proportion.</li> <li>Determine whether original power source is used.</li> <li>Use the test wire to test whether the sound is normal.</li> </ol>
	Intercom noise	<ol style="list-style-type: none"> <li>Determine whether it is noise due to the short-distance test of the two units.</li> <li>Whether the original power source is used.</li> <li>Whether the wire for installation is too thin or too long.</li> </ol>
Video	Black screen	<ol style="list-style-type: none"> <li>Inspect whether the indoor unit intercom indicator is on. If the intercom indicator is on, it means that the display screen or driver board has a failure and the board needs to be repaired or replaced.</li> <li>In case intercom is not working and the indicator is off, determine whether the power source is normal. If the power source is normal and the black screen remains, it is determined that the indoor unit mainboard needs to be repaired or replaced.</li> </ol>
	Blue screen	<ol style="list-style-type: none"> <li>Inspect whether the wires are correctly connected.</li> <li>If the blue screen remains after confirming the wires are correctly connected, it means that the outdoor camera needs to be replaced.</li> </ol>
	Blurred screen	<ol style="list-style-type: none"> <li>First of all, determine whether the display screen is damaged, and it shall be replaced if it is damaged.</li> <li>If the screen is normal, the driver board needs to be repaired or replaced.</li> </ol>
	The display screen is normally on	<ol style="list-style-type: none"> <li>The indoor unit mainboard needs to be repaired or replaced.</li> </ol>
	The display screen is normally on with whitening, black & white and too bright effects	<ol style="list-style-type: none"> <li>If it is whitening, it means that the driver board needs to be repaired or the screen and driver board need to be replaced.</li> <li>If it is black &amp; white, adjust the side color turbine. The driver board needs to be repaired or replaced if there is no response. The turbine may have a failure if the colors are unstable when adjusting the turbine, and the turbine or mainboard needs to be replaced.</li> <li>If it is too bright, the side turbine controls brightness, color and intercom sound respectively. Any user may choose the most appropriate position by itself.</li> </ol>

Failure Type	Failure Description	Failure Elimination
Call	No response after calling	<ol style="list-style-type: none"> <li>Inspect whether the power source is normal. Press the monitor button of the indoor unit to see whether the screen is normal. The power source is normal if the screen is normal. If the screen is off, use another power source to test it. If the screen is on, the power source has a failure. If the screen is still off, the indoor unit mainboard has a failure.</li> <li>If the screen is normal, please inspect whether the connection is correct.</li> <li>If the screen and wires are normal, short circuit the blue wire and black wire to see whether the indoor unit has ringtone. The outdoor unit has a failure if the blue screen has ringtone.</li> </ol>
	Intercom is normal but no ringtone is heard	<ol style="list-style-type: none"> <li>Inspect whether the mute mode is used. Reset it to see whether it can resume to normal state.</li> <li>If no ringtone can be heard after resetting it, the indoor unit mainboard needs to be repaired or replaced.</li> </ol>
Touch key	No response after pressing it	<ol style="list-style-type: none"> <li>Inspect whether the device gets stuck due to the rapid responses of the keys.</li> <li>Inspect whether many keys are pressed at the same time.</li> </ol>

## VI. Instructions

1. When cleaning the device, power it off first and use soft and dry cloth to wipe it;
2. Don't use benzene, diluent or organic solvent such as gasoline to wipe it, for these may damage the shell or discolor the device and keys;
3. The device shall be installed at a secure place with good ventilation, dry air and without direct sunlight, high-intensity magnetic field or dust;
4. Don't use it with any product not produced by our company;
5. Don't dismantle it without authorization. Please contact your local distributor or our technical department in case it has any failure;
6. Users shall follow the user manual strictly to install and test the product. Please call our company for technical support if you have any question;
7. The door-open button, electronic control lock and access control power supply are not accessories, and users need to purchase them by themselves;
8. The product is updated from time to time, so the manual is for your reference only. Please be subject to the actual product in case there are differences.